

SKEE Roll Puck & Display Panel

MODEL E

DELTRONIC LABS INC

SWT 9 OF 7

101577

SCORE

	"A" PRGM. "B"		"A" PRGM. "B"	
10	16-4	14-2	16-6	14-3
20	15-4		15-6	
30	14-4		14-6	
40	13-4		13-6	
50	12-5		12-6	
60	11-5		11-6	
70	10-5		10-7	
80	8-5		8-7	
90	9-5		9-7	
100	1-4	14-2	1-6	14-3
110	16-4	15-2	16-6	15-3
120	15-4		15-6	
130	14-4		14-6	
140	13-4		13-6	
150	12-5		12-6	
160	11-5		11-6	
170	10-5		10-7	
180	8-5		8-7	
190	9-5		9-7	
200	1-4	15-2	1-6	15-3
210	16-4	16-2	16-6	16-3
220	15-4		15-6	
230	14-4		14-6	
240	13-4		13-6	
250	12-5		12-6	
260	11-5		11-6	
270	10-5		10-7	
280	8-5		8-7	
290	9-5		9-7	
300	1-4	16-2	1-6	16-3
310	16-4	13-2	16-6	13-3
320	15-4		15-6	
330	14-4		14-6	
340	13-4		13-6	
350	12-5		12-6	
360	11-5		11-6	
370	10-5		10-7	
380	8-5		8-7	
390	9-5		9-7	
400	1-4	13-2	1-6	13-3
410	16-4	1-2	16-6	1-3
420	15-4		15-6	
430	14-4		14-6	
440	13-4		13-6	
450	12-5	1-2	12-6	1-3

180

SKEE ROLL PRGM. CHART
 MODEL E
 DELTRONIC LABS. INC.
 SWT 6 of 7
 1018

SCORE INCREMENTS

EVERY PROGRAM "B"

20 — 8-4.

30 — 12-5, 10-7-8, 11-6.

40 — 5-9, 10-8.

JUMPERS

BALL COUNT
PROGRAM "C"

6 — 13-4, 14-3, 8-9, 7-10

9 — 15-2, 16-1, 5-12, 6-11

JUMPERS:



2.4

JUMPERS ON PROGRAM CHIPS

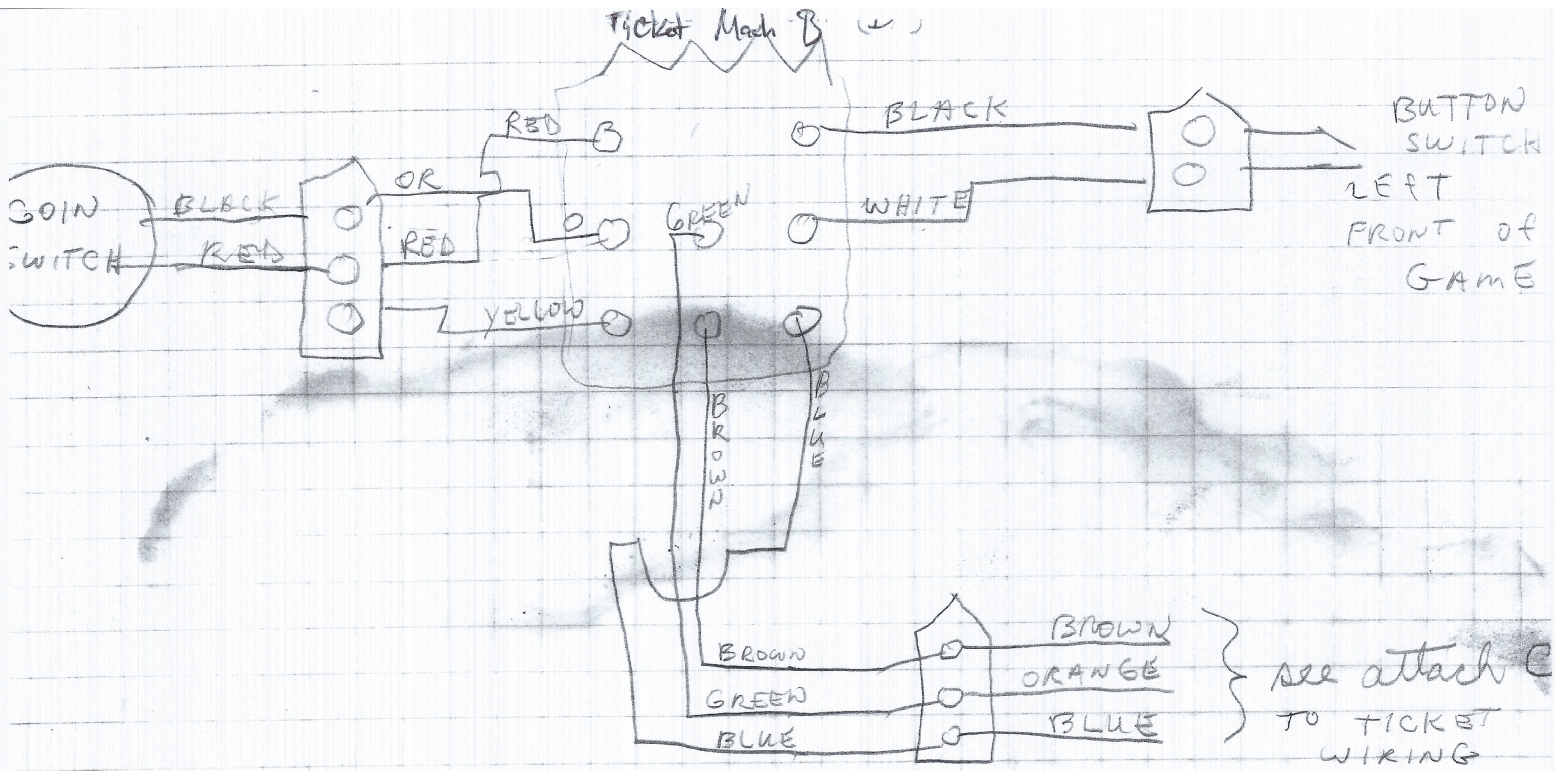

ATTACHMENT B

COIN START /
TICKET WIRES

Shee Ball 5 sets replacement part

#25

small tunnel 10' long, 5' hi

5 x 6

5343 Jarchood

978-1875

Merid Σ Koser

Chuck Chem

7:30 pm

280, Merid, to Jarchood,

1st before Branham,

2nd light is Jarchood,

left to last street

which is Jarchood,

at hand side at street

end. Jarchood tunnel.

ATTACHMENT A

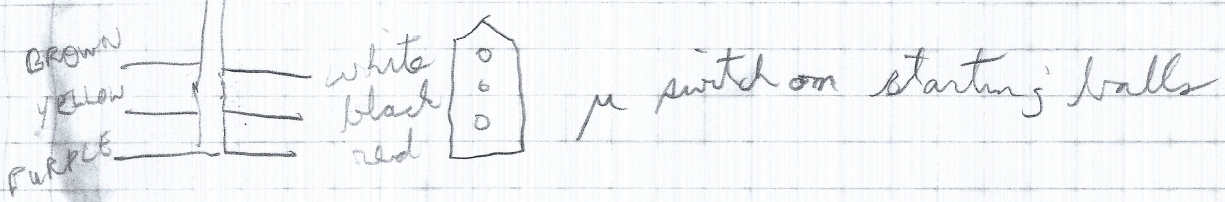
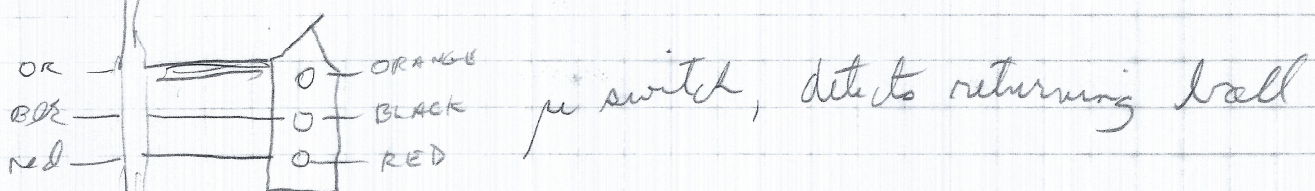
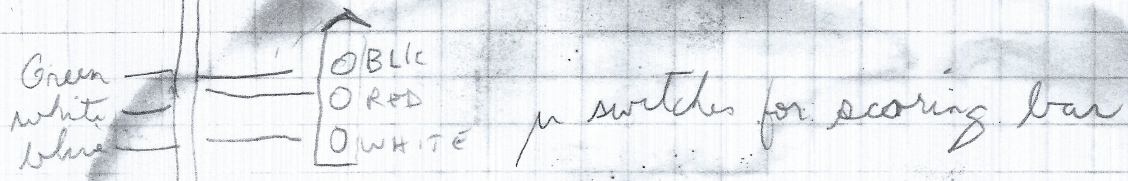
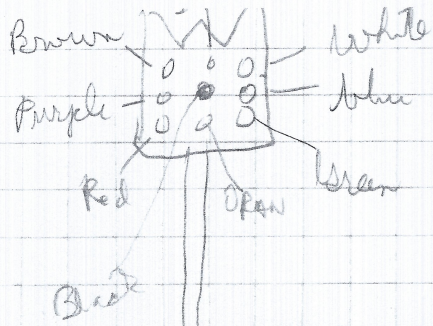

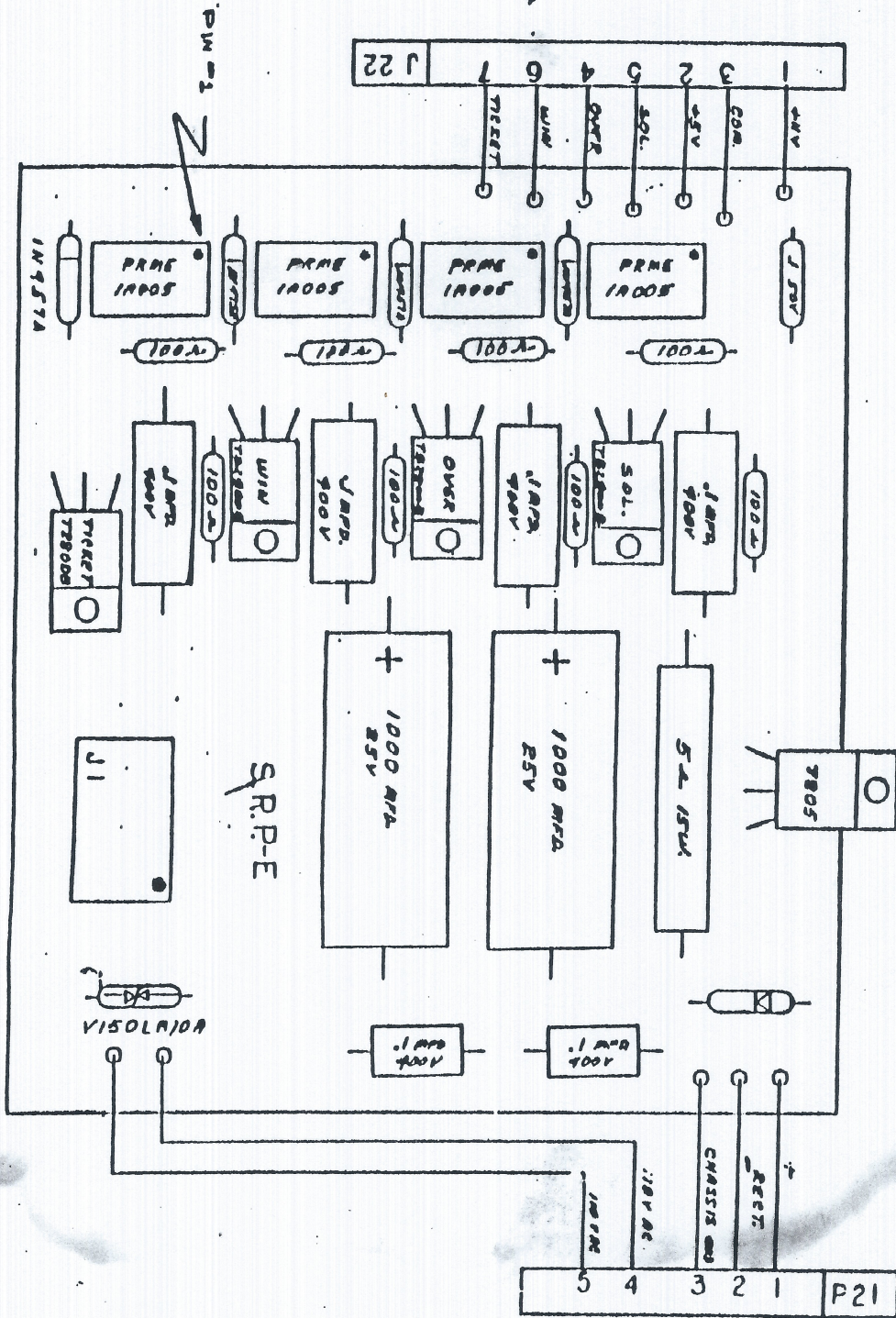

SKEE ROLL, FUR & DRIVER BOARD
 MODEL E
 DELTRONIC KRES INC.
 SHEET 5 OF 7
 101777

ATTACHMENT

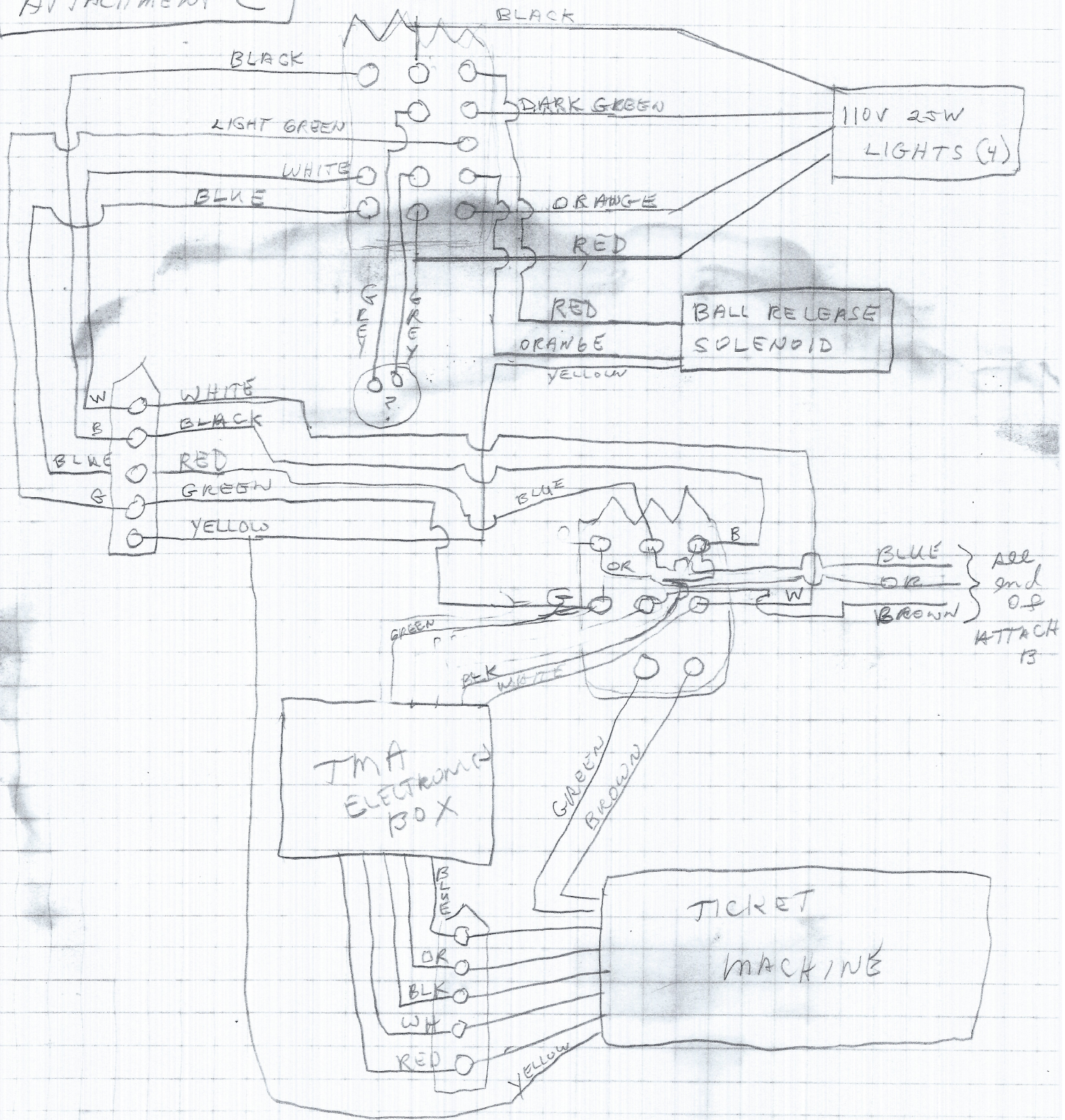

ALL
AND
O.P
ATTACH
13

BALL SOLENOID
TICKET MACHINE

7400 - 8

7404 - 2

7405 - 1

7408 - 3

7410 - 2

7442 - 2

7476 - 2

7485 - 1

7490 - 6

27 10's

1 - SIKSR

ATTACH A

TO M SWITCHES

- SCORING BAR

- RETURNING BALLS

- STARTING BALLS

MAIN PC BOARD

SCORING PANEL 0 A LIGHTS

- BALL COUNTER LIGHT DISPLAY

TIMER

POWER SUPPLY

110V LIGHTS

TICKET BALL SOCKET TRM BOX

ATTACH C

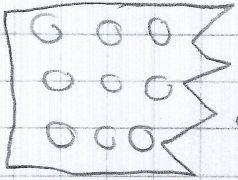

7400 OK

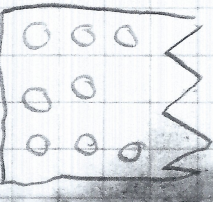

TICKET MACHINE \$ COIN (CB)

7460 OK

7476 OK

7408 OK

7490 OK

7492 OK



7400 OK

7405 OK

7408 OK

7490 D

7492 OK

7404 OK

7490 ?

7490 D

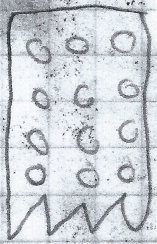

7400 OK



7410 OK

7410 OK

7485 OK

7408 OK

7490 ?

7404 OK

7476 D

7400 OK

7400 OK

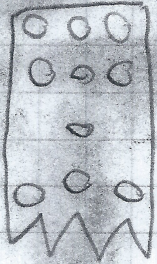

7400 OK

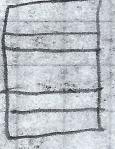

7490 D

7405 OK

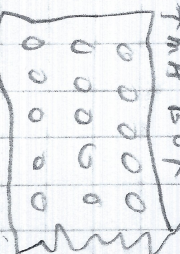
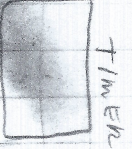

ATTACH C

ATTACHMENT H

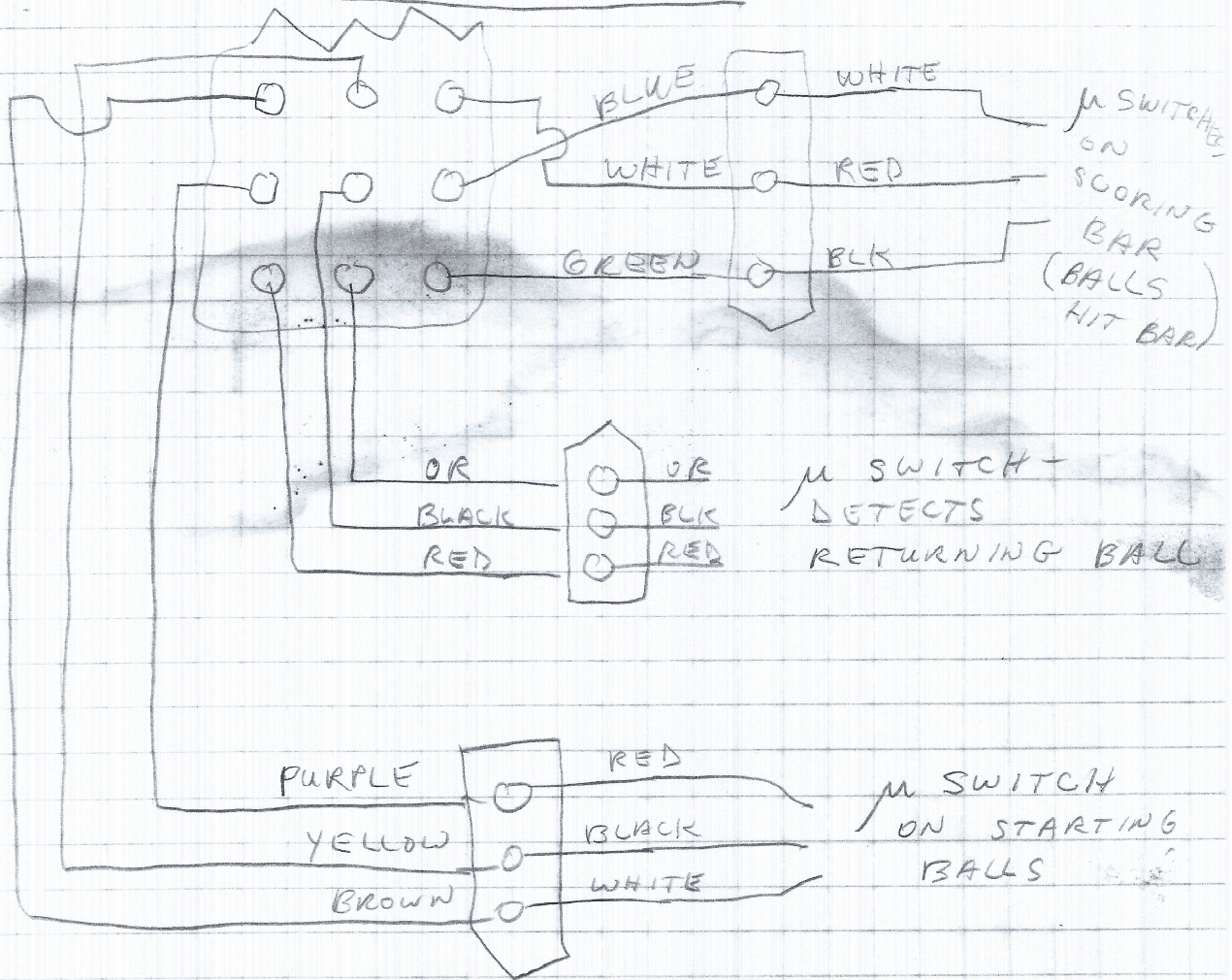

μ SWITCHES

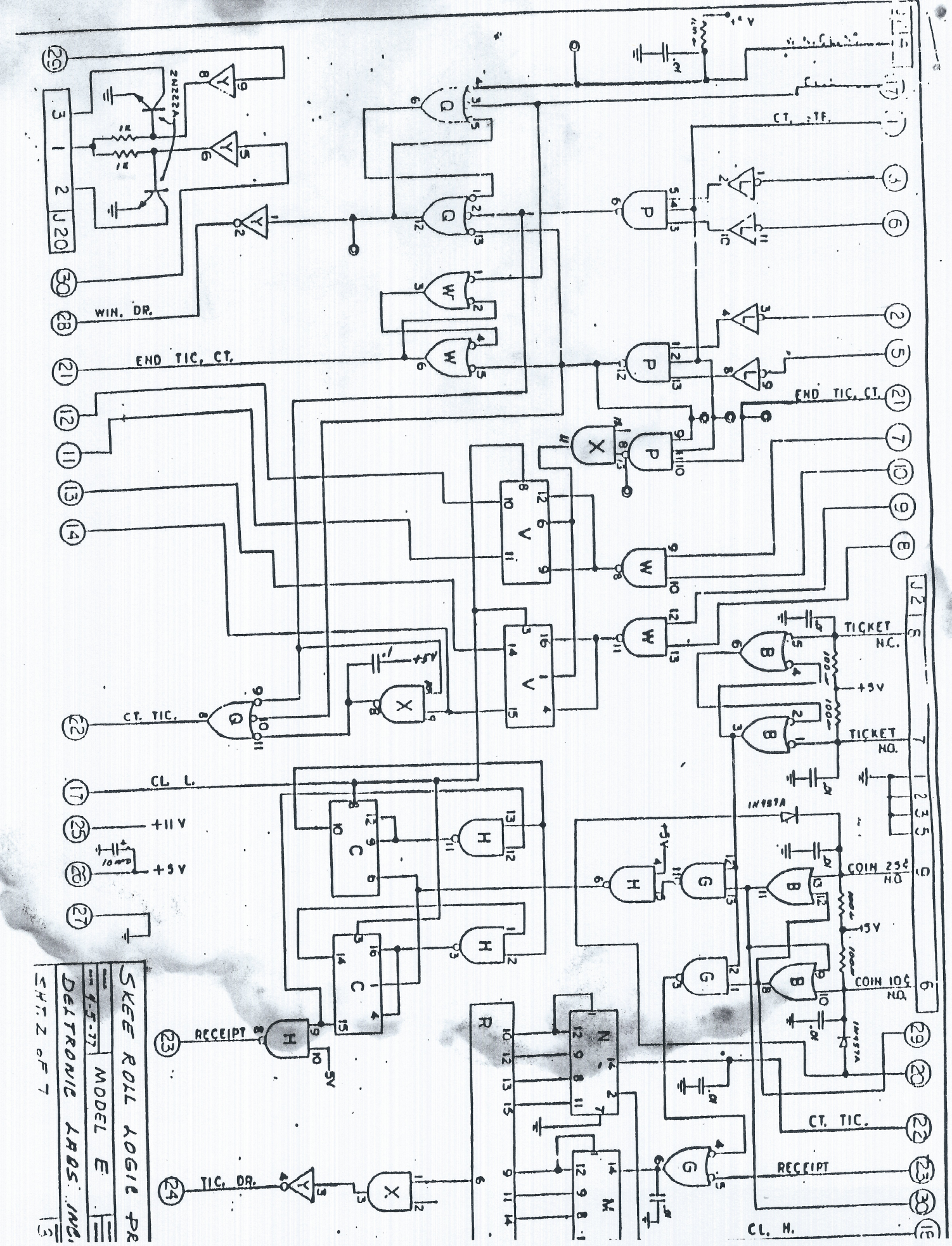

SKEEF ROLL YOGIC PR
 MODEL E
 DELTRONIC LABS. INC.
 CHIT 2 OF 7
 15

7400 - 8

7404 - 2

7405 - 1

7408 - 3

7410 - 2

7442 - 2

7476 - 2

7485 - 1

7490 - 6

27 10's

1 - SIKSR

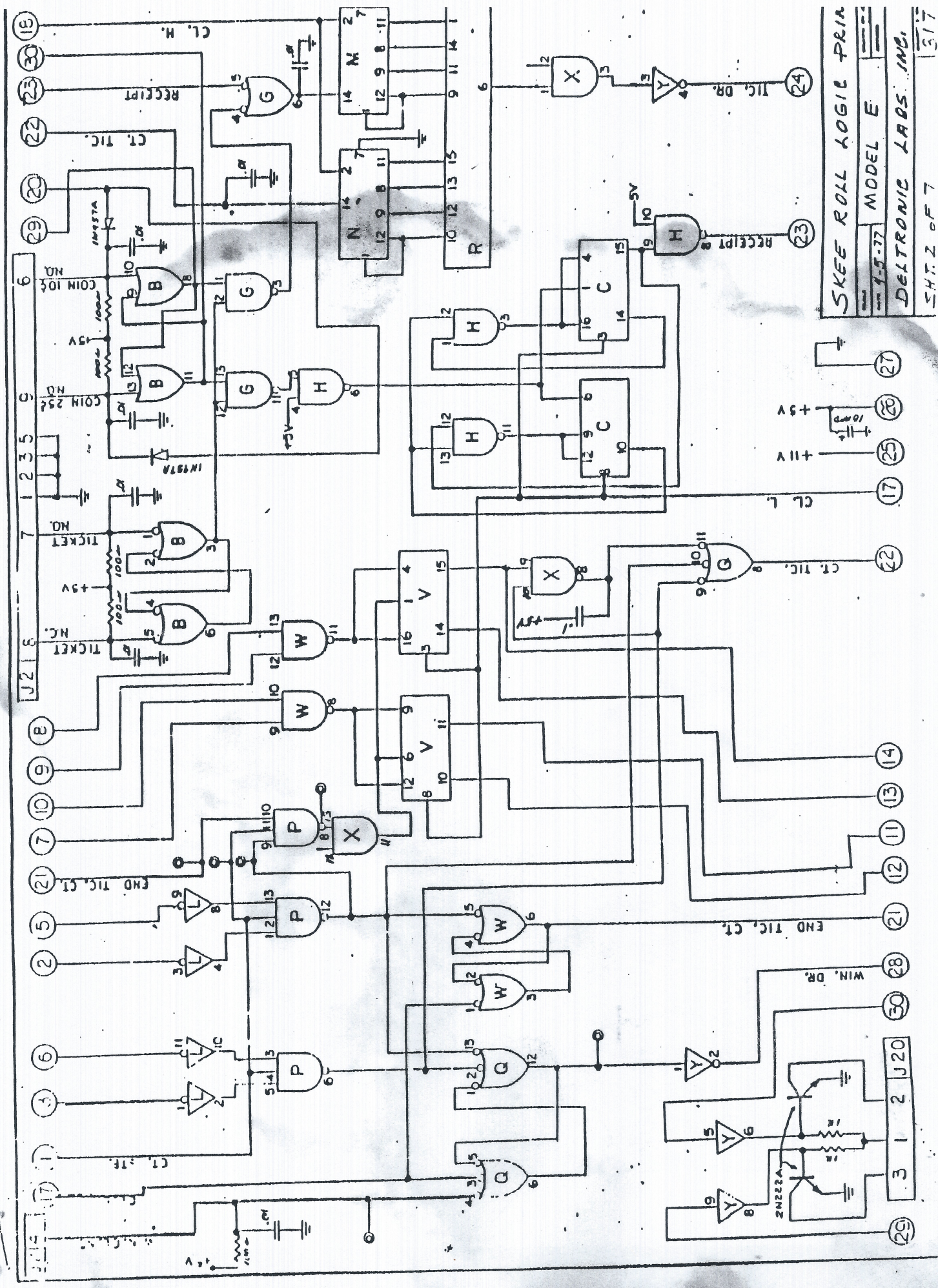

SKEE ROLL LOGIC PRIN
 MODEL E
 DELTRONIC LABS. INC.
 SHT. 2 OF 7

SRL-E

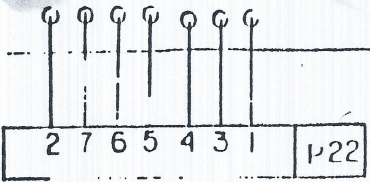
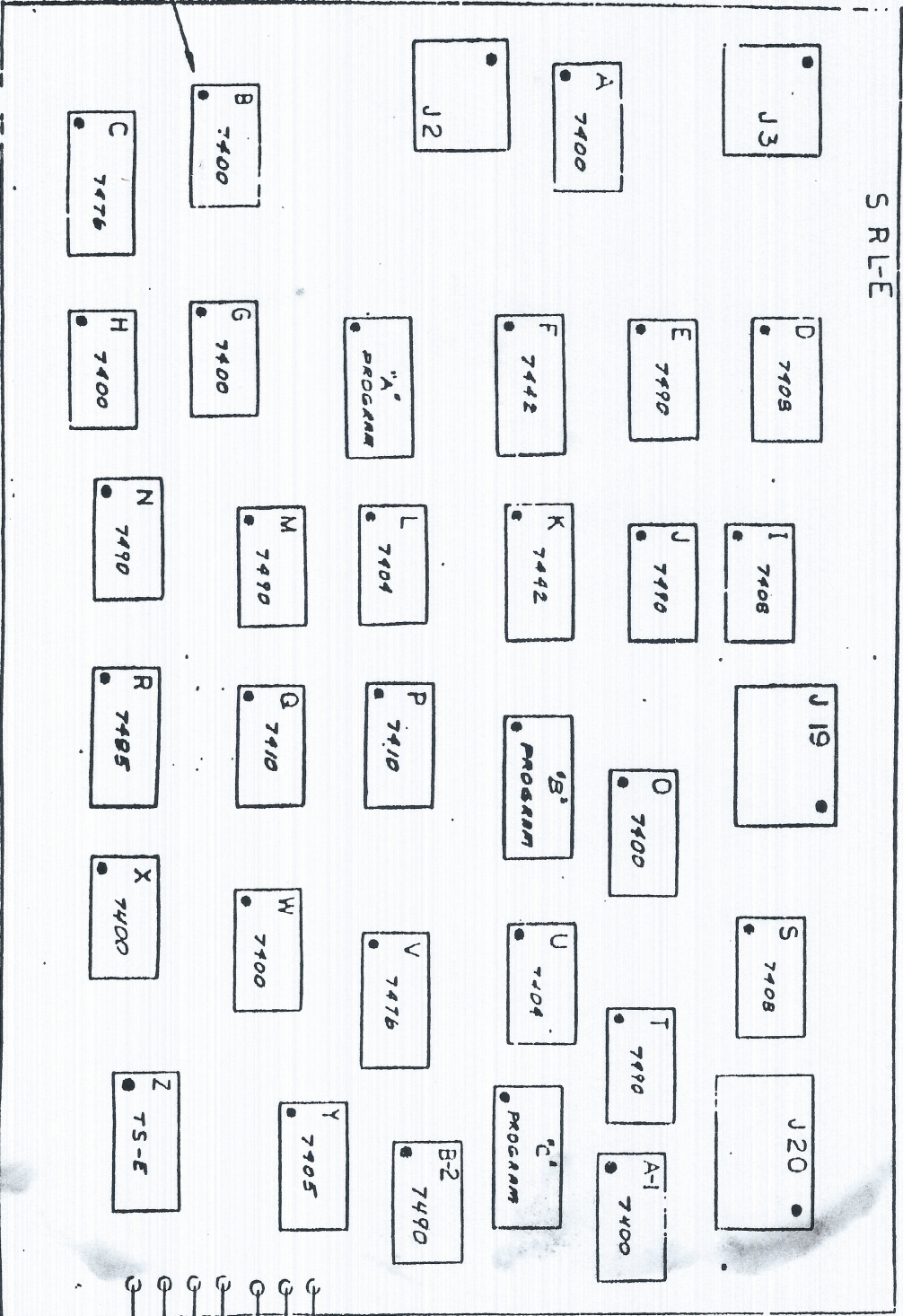

SKEE ROLL, LOGIC BOARD (SRL-E)
 MODEL E
 DELTRONIC LABS INC.
 SHT 4 of 7
 101677

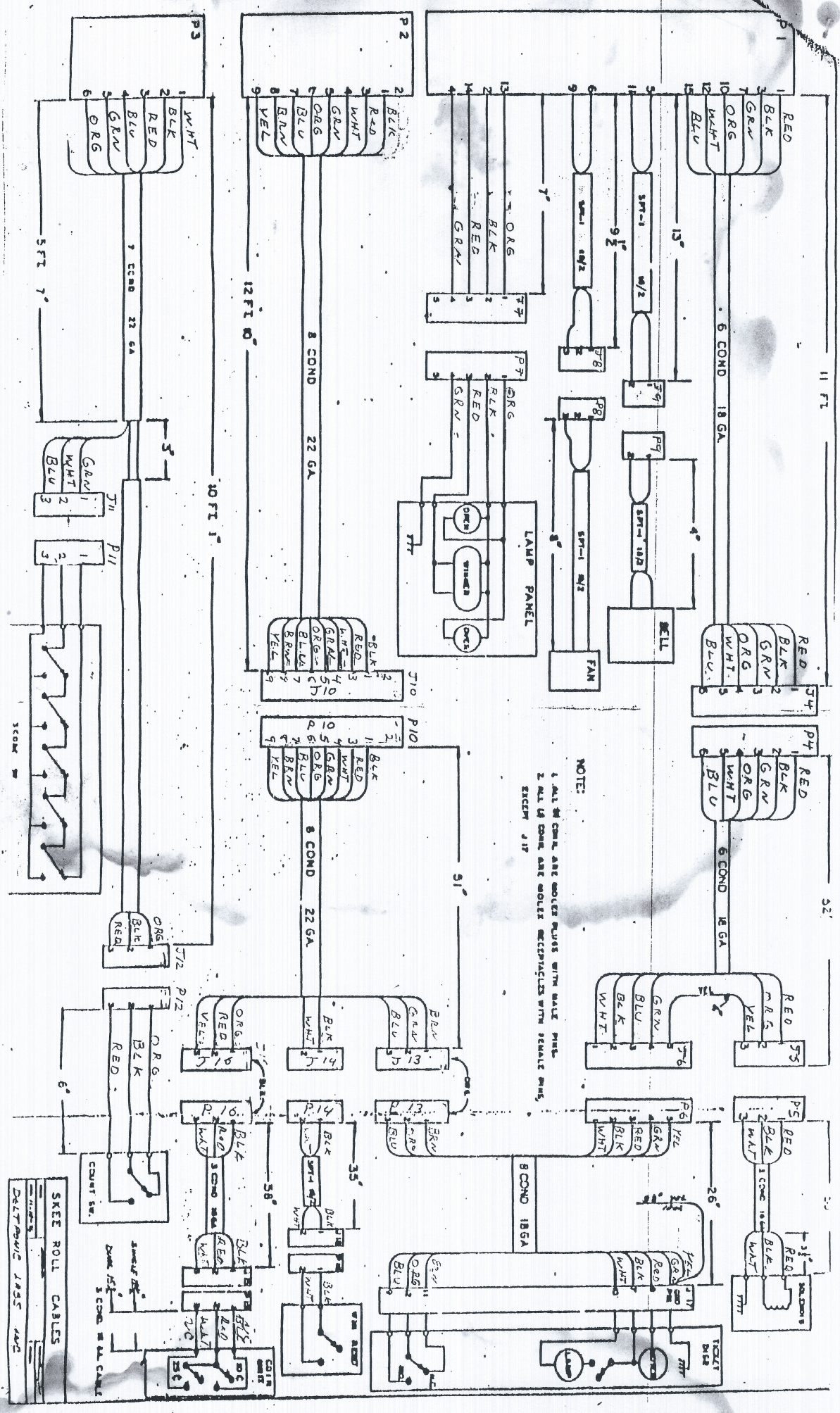

NOTE:
 1. ALL W/ CONN. ARE MALES PLUGS WITH MALE PINS.
 2. ALL W/ CONN. ARE MALES RECEPTACLES WITH FEMALE PINS.
 EXCEPT #17

SKEE ROLL CABLES
 DELTA PING 1485 1486

SCORE
Plug
attach C

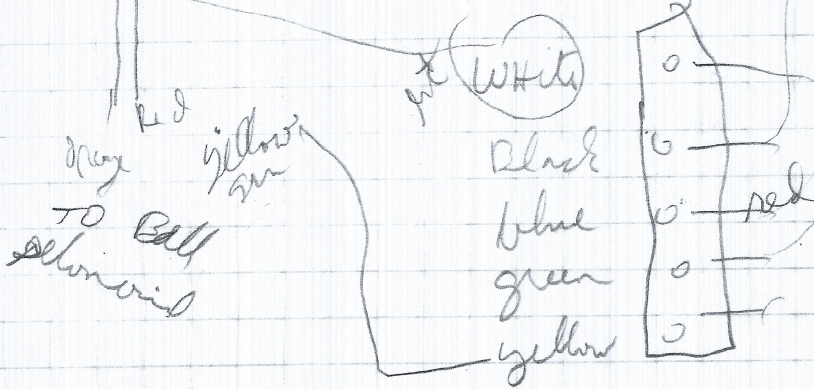
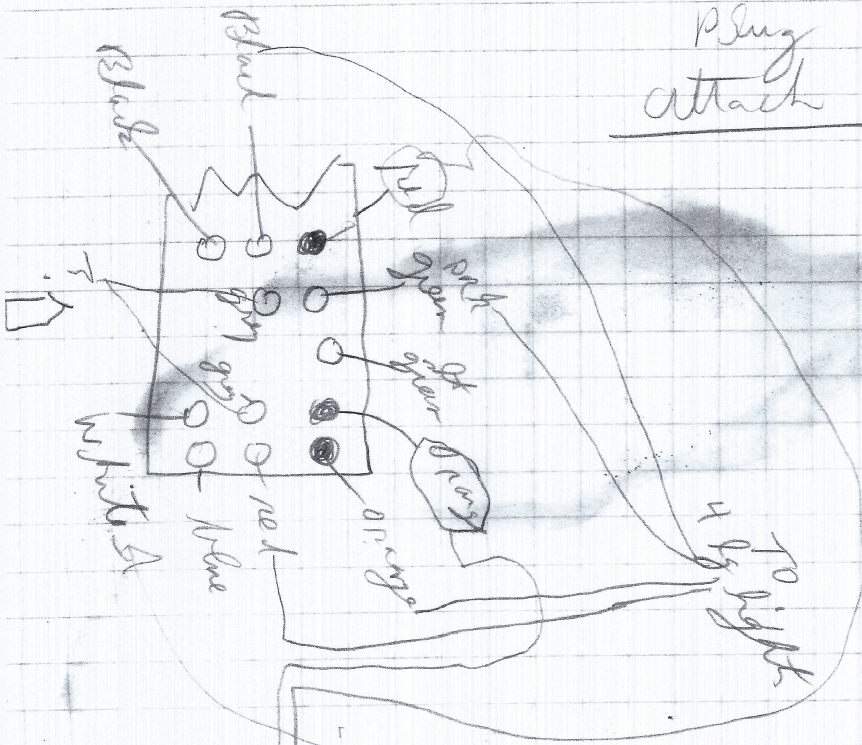

SCORE

STARTING SCORE

EXTRA SCORE

"A" PRGM. "B"

"A" PRGM. "B"

10	16-4	14-2	16-6	14-3
20	15-4		15-6	
30	14-4		14-6	
40	13-4		13-6	
50	12-5		12-6	
60	11-5		11-6	
70	10-5		10-7	
80	8-5		8-7	
90	9-5		9-7	
100	1-4	14-2	1-6	14-3
110	16-4	15-2	16-6	15-3
120	15-4		15-6	
130	14-4		14-6	
140	13-4		13-6	
150	12-5	15-2	12-6	
160	11-5		11-6	
170	10-5		10-7	
180	8-5		8-7	
190	9-5		9-7	
200	1-4	15-2	1-6	15-3
210	16-4	16-2	16-6	16-3
220	15-4		15-6	
230	14-4		14-6	
240	13-4		13-6	
250	12-5		12-6	
260	11-5		11-6	
270	10-5		10-7	
280	8-5		8-7	
290	9-5		9-7	
300	1-4	16-2	1-6	16-3
310	16-4	13-2	16-6	13-3
320	15-4		15-6	
330	14-4		14-6	
340	13-4		13-6	
350	12-5		12-6	
360	11-5		11-6	
370	10-5		10-7	
380	8-5		8-7	
390	9-5		9-7	
400	1-4	13-2	1-6	13-3
410	16-4	1-2	16-6	1-3
420	15-4		15-6	
430	14-4		14-6	
440	13-4		13-6	
450	12-5	1-2	12-6	1-3

SKEE ROIL PRGM CHART
 MODEL E
 DELTRONIC LABS. INC.
 SHT. 6 OF 7
 1018772

SCORE INCREMENTS
 EVERY PROGRAM "B"
 20 - 8-4.
 30 - 12-5, 10-7-8, 11-6.
 40 - 5-9, 10-8.
 JUMPERS

BALL COUNT
 PROGRAM "C"
 5 - 16-1, 13-2, 12-5, 10-8
 6 - 13-4, 14-3, 8-9, 7-10
 9 - 15-2, 16-1, 5-12, 6-11
 JUMPERS

JUMPERS ON PROGRAM CHIPS

ATTACHMENT A

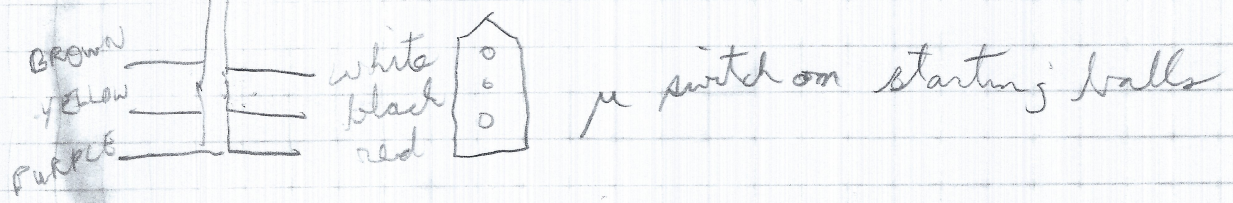
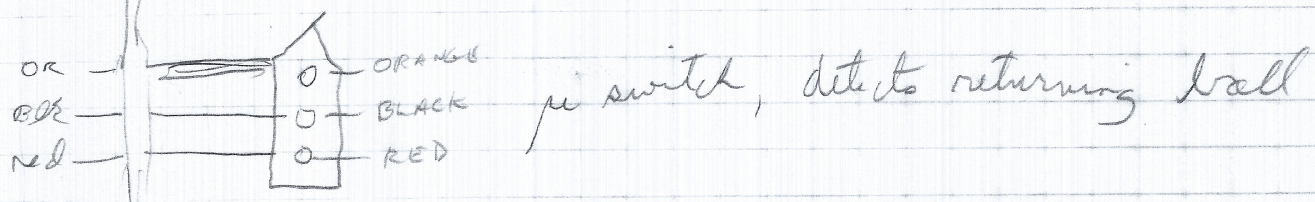
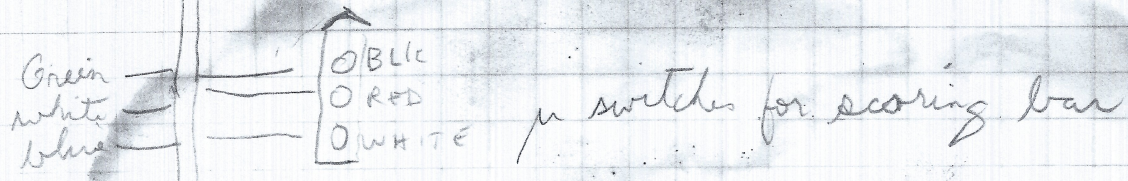
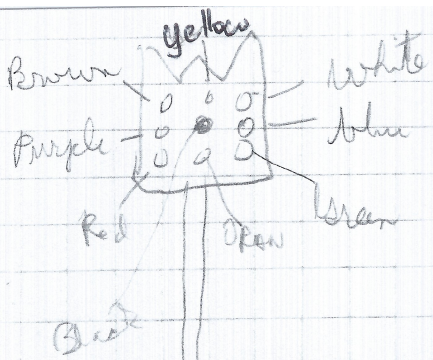

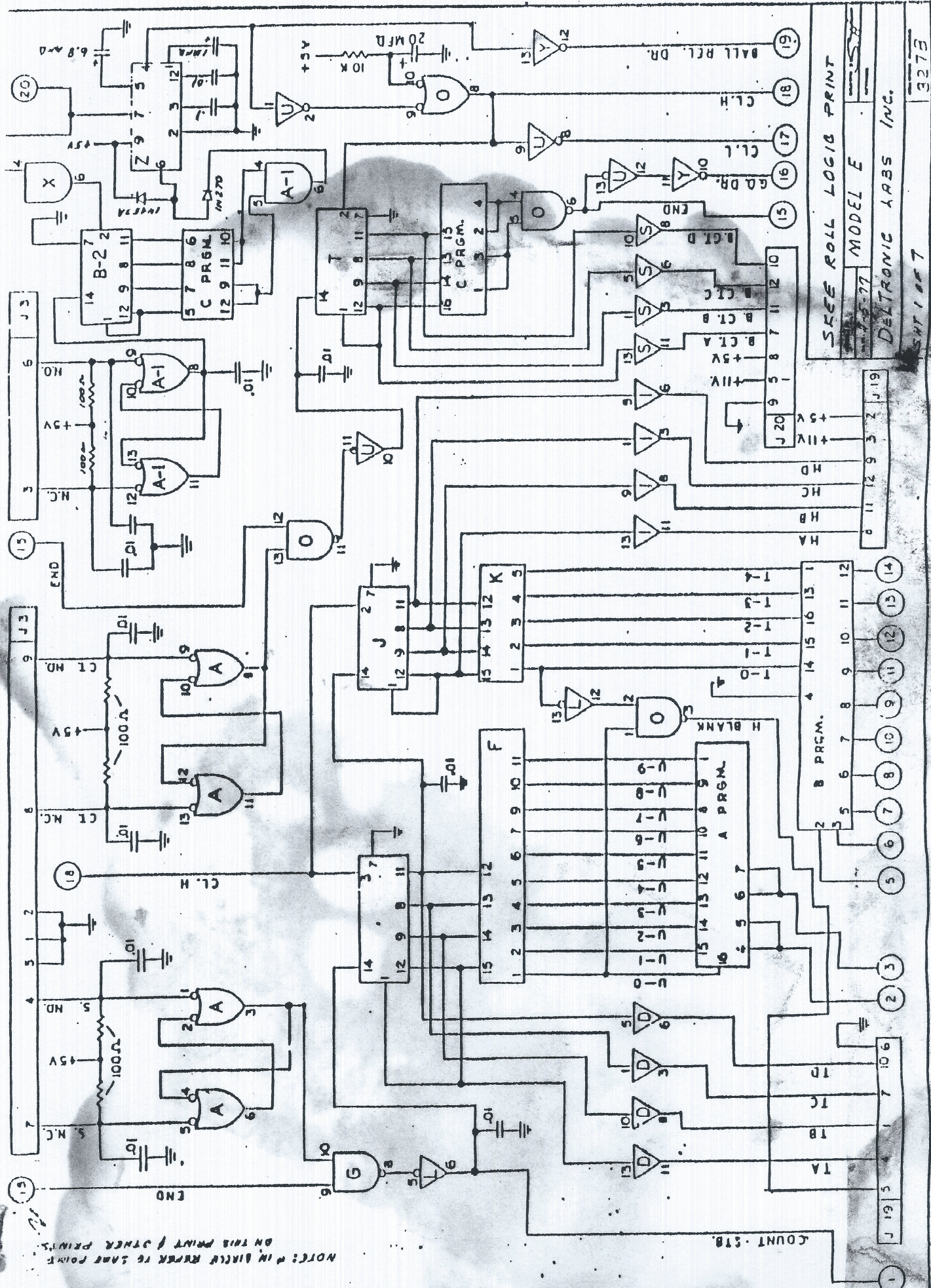

SEEK ROLL LOGIC PRINT
MODEL E
DELTRONIC LABS INC.
SHEET 7 OF 7

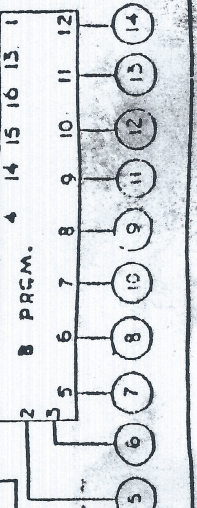
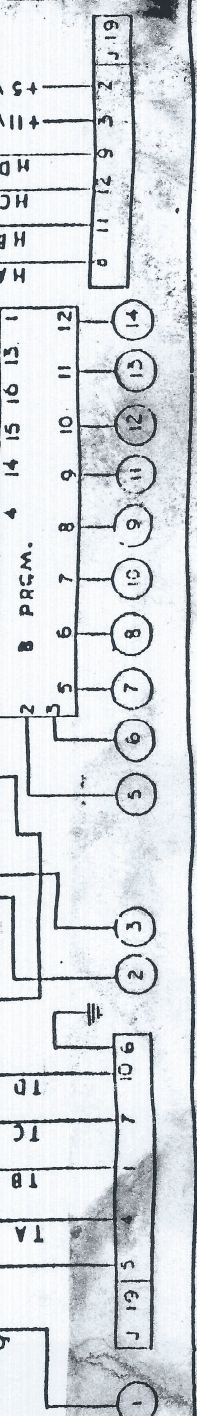

TO TICKET
COUNTER
ATTACHMENT B

